

2.CKL SERIES

L Brackets Mounting Dry Type Power Transformer

EI75/26

2.CKL Series



- Rated power: 50VA
- Safety Isolating & Isolating Transformers
- Non-short-circuit proof
- Ambient temperature 40°C
- Temperature Class B
- Self-extinguishing plastics UL94HB
- Degree of protection IP00
- Clamp Terminals for Currents up to 60A
- Moisture protected by varnish
- High electrical safety and long service-life features
- In compliance with: EN61558-1, EN61558-2-4, EN61558-2-6
- Weight: 980 g

Approvals:



Electrical Data:

Primary Voltage	Secondary Voltage			Voltage Drop	Rated Power	Width*	Safety Isolating / Isolating transformers	2.CKL Series
	With Load		No Load					
[V]	[V]	@ [A]	[V]	[%]	[VA]	B / C[mm]	[SIT / IT]	Order code
230	12	4.17	13.4	12	50	82 / 51.0	SIT	2.CKL.E07526.209
230	2 x 12	2.08	2 x 13.4	12	50	82 / 51.0	SIT	2.CKL.E07526.210
230	21	2.38	23.5	12	50	82 / 51.0	SIT	2.CKL.E07526.215
230	24	2.08	26.9	12	50	82 / 51.0	SIT	2.CKL.E07526.217
230	2 x 24	1.04	2 x 26.9	12	50	82 / 51.0	SIT	2.CKL.E07526.218
230	36	1.39	40.3	12	50	82 / 51.0	SIT	2.CKL.E07526.221
230	42	1.19	47.0	12	50	82 / 51.0	SIT	2.CKL.E07526.223
230	48	1.04	53.8	12	50	82 / 51.0	SIT	2.CKL.E07526.225
230	42, 48	1.04	47.0, 53.8	12	50	82 / 51.0	SIT	2.CKL.E07526.240
230	115	0.43	129	12	50	82 / 51.0	IT	2.CKL.E07526.260
230	230	0.22	258	12	50	82 / 51.0	IT	2.CKL.E07526.270
230	400	0.13	448	12	50	82 / 51.0	IT	2.CKL.E07526.280
400	12	4.17	13.4	12	50	82 / 51.0	SIT	2.CKL.E07526.409
400	2 x 12	2.08	2 x 13.4	12	50	82 / 51.0	SIT	2.CKL.E07526.410
400	21	2.38	23.5	12	50	82 / 51.0	SIT	2.CKL.E07526.415
400	24	2.08	26.9	12	50	82 / 51.0	SIT	2.CKL.E07526.417
400	2 x 24	1.04	2 x 26.9	12	50	82 / 51.0	SIT	2.CKL.E07526.418
400	36	1.39	40.3	12	50	82 / 51.0	SIT	2.CKL.E07526.421
400	42	1.19	47.0	12	50	82 / 51.0	SIT	2.CKL.E07526.423
400	48	1.04	53.8	12	50	82 / 51.0	SIT	2.CKL.E07526.425
400	42, 48	1.04	47.0, 53.8	12	50	82 / 51.0	SIT	2.CKL.E07526.440
400	115	0.43	129	12	50	82 / 51.0	IT	2.CKL.E07526.460
400	230	0.22	258	12	50	82 / 51.0	IT	2.CKL.E07526.470
400	400	0.13	448	12	50	82 / 51.0	IT	2.CKL.E07526.480

* See Mechanical Data

2.CKL SERIES

L Brackets Mounting Dry Type Power Transformer

EI75/26

Possible Connection Types:

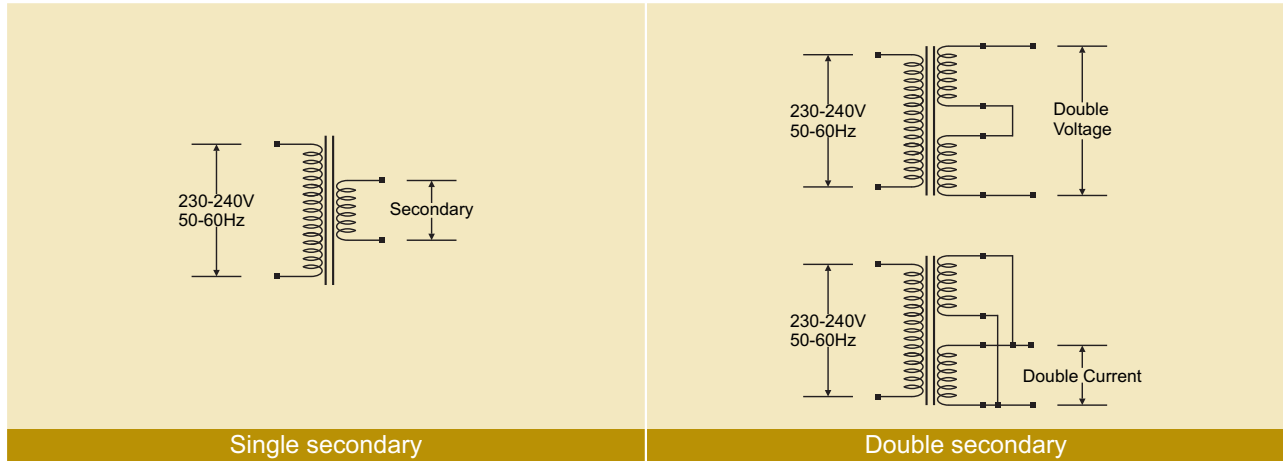

Mechanical Data:

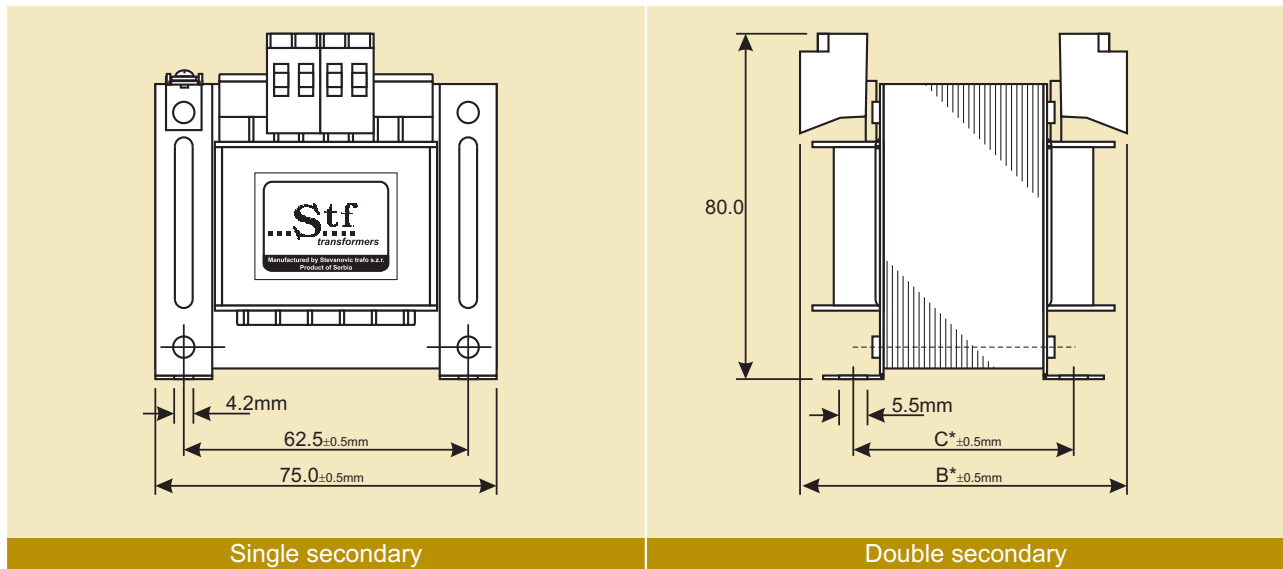

*Transformer width is given in table with Electrical Data

Types available on request:

Primary Voltage	Secondary Voltage			Voltage Drop	Rated Power	Width*	Safety Isolating / Isolating transformers	9.xxx Series
	With Load		No Load					
[V]	[V]	@ [A]	[V]	[%]	[VA]	B / C[mm]	[SIT / IT]	Order code
<600			<400	12	50	82 / 51.0	IT	9.xxx.E07526.xxx
<600			<400	10	63	88 / 57.0	IT	9.xxx.E07532.xxx
<600			<400	10	75	91 / 60.0	IT	9.xxx.E07535.xxx
<600			<400	10	85	97 / 66.0	IT	9.xxx.E07541.xxx

*See Mechanical Data